



4K Ultra HD 600 MHz HDBaseT™ Extenders

GTB-UHD600-HBT
GTB-UHD600-HBTL



User Manual

Version A2

Important Safety Instructions

1. Read these instructions.
2. Keep these instructions.
3. Heed all warnings.
4. Follow all instructions.
5. Do not use this product near water.
6. Clean only with a dry cloth.
7. Do not block any ventilation openings. Install in accordance with the manufacturer's instructions.
8. Do not install or place this product near any heat sources such as radiators, heat registers, stoves, or other apparatus (including amplifiers) that produce heat.
9. Do not defeat the safety purpose of the polarized or grounding-type plug. A polarized plug has two blades with one wider than the other. A grounding type plug has two blades and a third grounding prong. The wide blade or the third prong are provided for your safety. If the provided plug does not fit into your outlet, consult an electrician for replacement of the obsolete outlet.
10. Protect the power cord from being walked on or pinched particularly at plugs, convenience receptacles, and the point where they exit from the apparatus.
11. Only use attachments/accessories specified by the manufacturer.
12. To reduce the risk of electric shock and/or damage to this product, never handle or touch this unit or power cord if your hands are wet or damp. Do not expose this product to rain or moisture.
13. Unplug this apparatus during lightning storms or when unused for long periods of time.
14. Refer all servicing to qualified service personnel. Servicing is required when the apparatus has been damaged in any way, such as power-supply cord or plug is damaged, liquid has been spilled or objects have fallen into the apparatus, the apparatus has been exposed to rain or moisture, does not operate normally, or has been dropped.
15. Batteries that may be included with this product and/or accessories should never be exposed to open flame or excessive heat. Always dispose of used batteries according to the instructions.

Warranty Information

For the latest warranty coverage information, refer to the Warranty and Return Policy under the Connect section of the Gefen website at <http://www.gefen.com/connect/warranty-and-return-policy>

Technical Support

1-707-283-5900 1-800-472-5555
8:00 AM to 5:00 PM Monday - Friday, Pacific Time

Email

support@gefen.com

Web

<http://www.gefen.com>

Mailing Address

Gefen
Core Brands, LLC
c/o Customer Service
1800 S McDowell Blvd
Petaluma, CA 94954 USA

© 2017 Core Brands, LLC. All Rights Reserved.

All trademarks are the property of their respective owners.

Gefen and Core Brands, LLC reserve the right to make changes in the hardware, packaging, and any accompanying documentation without prior notice.

Important

- While Unshielded (UTP) CAT-5e is usually adequate, shielded (STP) CAT-6A is recommended. Shielded (STP) CAT-5e or unshielded (UTP) CAT-5e or CAT-6A may be acceptable depending on cable quality. Care should always be given to keep these cables away from power lines and other sources of electromagnetic interference.
- Cable quality is critical when handling 600 MHz HDMI signals. We highly recommend 10-foot or shorter Gefen Locking HDMI cables. They have been designed and tested to work at 600 MHz and reliably transport the the full 18.2 Gbps throughput of HDMI 2.0.
- The Sender unit has 2 EDID Management DIP Switches on its bottom panel, under a self-adhesive cover. This product is shipped with its DIP switches set to enable 4K with 2-Channel Audio mode (SW1: ON, SW2: OFF). Please see the manual for details before changing the DIP Switch settings.
- The GTB-UHD600-HBT and GTB-UHD600-HBTL vary in maximum extension distances, based on resolution / timing and color depth. Refer to the Features section on pages 6 and 7 for more information .
- Power Over Line (POL) is a proprietary Gefen implementation that provides power over the link cable. The GTB-UHD600-HBT and GTB-UHD600-HBTL feature Bi-Directional POL, meaning that the power supply (1 pc included) can be connected to either the Sender or the Receiver unit.
- The information in this manual has been carefully checked and is believed to be accurate. However, Gefen and Core Brands, LLC assume no responsibility for any inaccuracies that may be contained in this manual. In no event will Gefen and Core Brands, LLC be liable for direct, indirect, special, incidental, or consequential damages resulting from any defect or omission in this manual.
- All information contained herein is subject to change without notice.



This product uses UL-Listed power supplies



Features & Packing List

Features (GTB-UHD600-HBT)*

- Supports 18.2 Gbps bandwidth and 600 MHz TMDS clock
- Extends HDMI, RS-232, & Bi-Directional IR over a single CAT-5e/CAT-6A:
 - * 4K Ultra HD (3840 x 2160 to 60 Hz, 4:4:4), up to 264 feet/80 meters (8-bit color)
 - * 4K Cinema (DCI) (4096 x 2160 to 60 Hz 4:4:4), up to 264 feet/80 meters (8-bit color)
 - * 1080p Full HD (60 Hz) and WUXGA (1920 x 1200 to 60 Hz), up to 330 feet/100 meters (up to 12-bit Deep Color)
- HDMI Features Supported:
 - * HDMI 2.0 (full bandwidth to 18.2 Gbps/600 MHz)
 - * HDR-10: 10-bit color at 4K 60 Hz 4:2:0 and 4K 24 Hz 4:4:4
 - * Dolby® Vision™ HDR: 12-bit color at 4K 60Hz 4:2:0 and 4K 24 Hz 4:4:4
 - * HDCP 2.2 and 1.4
 - * 12-bit Deep Color (at 1080p)
 - * Uncompressed LPCM digital audio up to 7.1 channels
 - * HBR (High Bit Rate) digital audio up to 7.1 channels, including Dolby Atmos®, Dolby® TrueHD, DTS:X™, and DTS-HD Master Audio™
 - * 3DTV pass-through
 - * CEC pass-through
 - * Lip Sync pass-through
- Supports the use of DVI sources and DVI displays up to 1080p Full HD and WUXGA (1920x1200), with Gefen CAB-DV1zHDMI-LCK DVI-to-HDMI cables (not included)
- RS-232 2-way link between Sender and Receiver
- IR extension from Sender to Receiver and from Receiver to Sender
- Gefen's Bi-Directional POL provides power to the Sender or the Receiver unit over the link cable - only one side will need external power
- Uses Gefen's implementation of HDBaseT™ technology with proprietary algorithms and enhanced features
- Advanced EDID Management
- Firmware updatable via RS-232 using Gefen Syner-G™
- Locking power connector
- Plug & Play – no configuration or set-up required for most applications
- Surface mountable
- Compact enclosures are easy to install and can be hidden away

*Features and specifications are subject to change without notice.

All trademarks and registered trademarks are properties of their respective owners.

Features (GTB-UHD600-HBTL)*

- Supports 18.2 Gbps bandwidth and 600 MHz TMDS clock
- Extends HDMI & Bi-Directional IR over a single CAT-5e/CAT-6A:
 - * 4K Ultra HD (3840 x 2160 to 60 Hz, 4:4:4), up to 132 feet/40 meters (8-bit color)
 - * 4K Cinema (DCI) (4096 x 2160 to 60 Hz 4:4:4), up to 132 feet/40 meters (8-bit color)
 - * 1080p Full HD (60 Hz) and WUXGA (1920 x 1200 to 60 Hz), up to 200 feet/60 meters (up to 12-bit Deep Color)
- HDMI Features Supported:
 - * HDMI 2.0 (full bandwidth to 18.2 Gbps/600 MHz)
 - * HDR-10: 10-bit color at 4K 60 Hz 4:2:0 and 4K 24 Hz 4:4:4
 - * Dolby® Vision™ HDR: 12-bit color at 4K 60Hz 4:2:0 and 4K 24 Hz 4:4:4
 - * HDCP 2.2 and 1.4
 - * 12-bit Deep Color (at 1080p)
 - * Uncompressed LPCM digital audio up to 7.1 channels
 - * HBR (High Bit Rate) digital audio up to 7.1 channels, including Dolby Atmos®, Dolby® TrueHD, DTS:X™, and DTS-HD Master Audio™
 - * 3DTV pass-through
 - * CEC pass-through
 - * Lip Sync pass-through
- Supports the use of DVI sources and DVI displays up to 1080p Full HD and WUXGA (1920x1200), with Gefen CAB-DVI2HDMI-LCK DVI-to-HDMI cables (not included)
- IR extension from Sender to Receiver and from Receiver to Sender
- Gefen's Bi-Directional POL provides power to the Sender or the Receiver unit over the link cable - only one side will need external power
- Uses Gefen's implementation of HDBaseT™ technology with proprietary algorithms and enhanced features
- Advanced EDID Management
- Firmware updatable via Gefen Syner-G™ port
- Locking power connector
- Plug & Play – no configuration or set-up required for most applications
- Surface mountable
- Compact enclosures are easy to install and can be hidden away

*Features and specifications are subject to change without notice.

All trademarks and registered trademarks are properties of their respective owners.

Packing List* (GTB-UHD600-HBT)

The following items are included in the GTB-UHD600-HBT package. If any of these items are not present in the box when you first open it, please contact Gefen Technical Support as soon as possible.

- (1) Sender Unit (GTB-UHD600-HBT-TX)
- (1) Receiver Unit (GTB-UHD600-HBT-RX)
- (1) HDMI-to-HDMI Male-to-Male Locking cable, 6 feet
- (1) IR Emitter (EXT-IREMIT)
- (1) IR Extender (EXT-RMT-EXTIRN)
- (1) 12V DC power supply with US/EU/UK/AU regional AC plugs and 5.5mm/2.1mm DC plug (EXT-PS121.5AIP-LP-6)

Packing List* (GTB-UHD600-HBTL)

The following items are included in the GTB-UHD600-HBTL. If any of these items are not present in the box when you first open it, please contact Gefen Technical Support as soon as possible.

- (1) Sender Unit (GTB-UHD600-HBTL-TX)
- (1) Receiver Unit (GTB-UHD600-HBTL-RX)
- (1) HDMI-to-HDMI Male-to-Male Locking cable, 6 feet
- (1) IR Emitter (EXT-IREMIT)
- (1) IR Extender (EXT-RMT-EXTIRN)
- (1) 12V DC power supply with US/EU/UK/AU regional AC plugs and 5.5mm/2.1mm DC plug (EXT-PS121.5AIP-LP-6)

*Features and specifications are subject to change without notice.

All trademarks and registered trademarks are properties of their respective owners.

Table of Contents

Introduction	10
GTB-UHD600-HBT	10
GTB-UHD600-HBTL.....	15
Installation	20
Connection Instructions.....	20
Sample Wiring Diagrams	21
LED Status	22
IR Control	23
Controlling the Source from the Viewing Location	23
Controlling the Display from the Source Location	24
Controlling the Source / Display from the Head-End and Viewing Locations.....	25
DIP Switch Configuration	26
EDID Management	26
RS-232*	27
Firmware Update	28
Specifications	29

* GTB-UHD600-HBT only

GTB-UHD600-HBT

Sender Unit

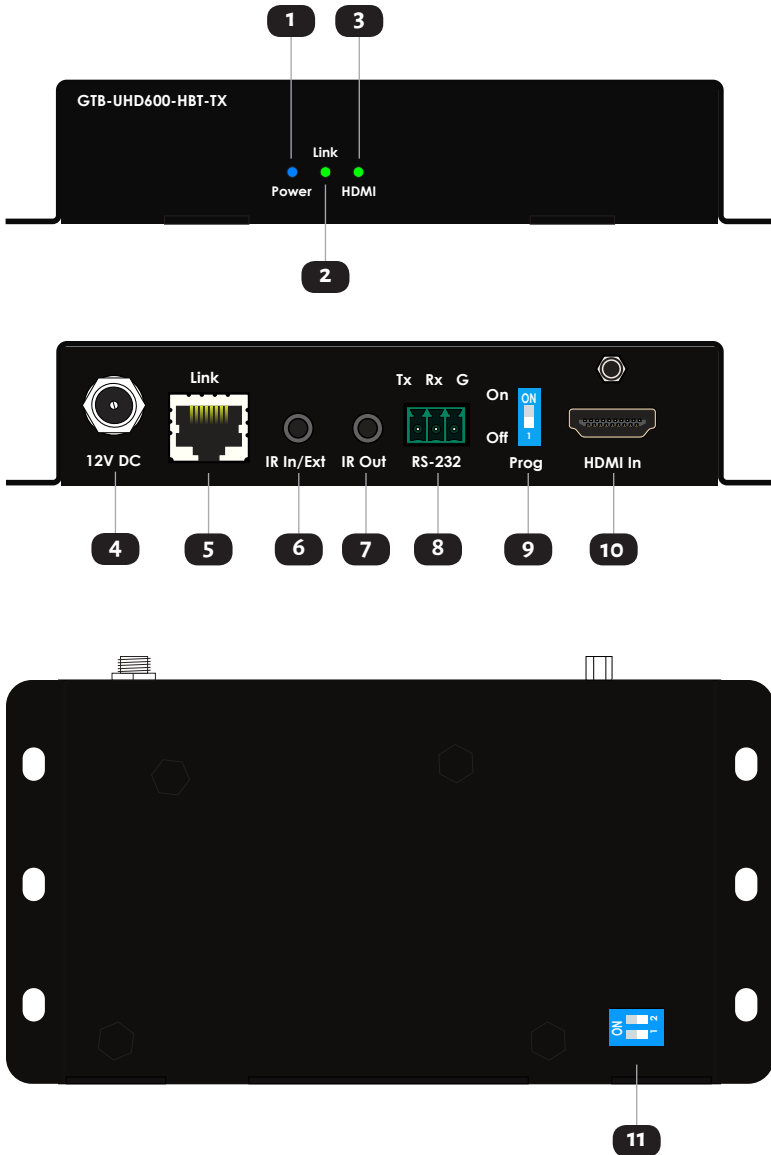

ID	Name	Description
1	Power	This LED indicator glows solid blue when the unit is powered. See LED Status (page 22) for more information.
2	Link	This LED glows solid green when a link is established between the Sender and Receiver. See LED Status (page 22) for more information.
3	HDMI	This LED indicator glows solid green when a source is connected to the HDMI In port. See LED Status (page 22) for more information.
4	12V DC	This power receptacle is used to connect the included 12V DC power supply. Only one power supply is required for the extender system to operate. The power supply can be connected to either the Sender or Receiver unit.
5	Link	Connect a CAT-5e or better cable, shielded CAT-6A preferred, up to the recommended length for a given resolution, from this port to the Link port on the Receiver unit.
6	IR In/Ext	3.5mm mini-stereo jack. Connect an IR Extender (Gefen part no. EXT-RMT-EXTIRN) to this port. Alternatively, connect a 3.5mm mini-stereo connector from this port to the output of an automation system with an electrical IR output. See IR Control (page 23) for more information on using IR.
7	IR Out	Connect an EXT-IREMIT IR Emitter (1 pc included) from this port to the IR sensor of the device to be controlled. See IR Control (page 23) for more information on using IR.

ID	Name	Description
8	RS-232	Connect RS-232 Tx, Rx, and Ground from an automation control device, using the removable 3-pin “Captive Screw” Phoenix connector that is attached to the RS-232 port of the Sender unit.
9	Prog	For normal operation, this switch should be in the Off (down) position. Setting this switch to the On (up) position, places the unit in firmware update mode. If either the Sender or the Receiver switch is in On position, extenders will not work. For the new setting of this switch to take effect, power needs to be removed from the unit by removing and reinstated by reconnecting them.
10	HDMI In	Use the included Locking HDMI cable to connect an Ultra HD source to this HDMI port.
11	DIP Switches	These DIP switches provide EDID management. See DIP Switch Configuration (page 26) for more information.

Receiver Unit

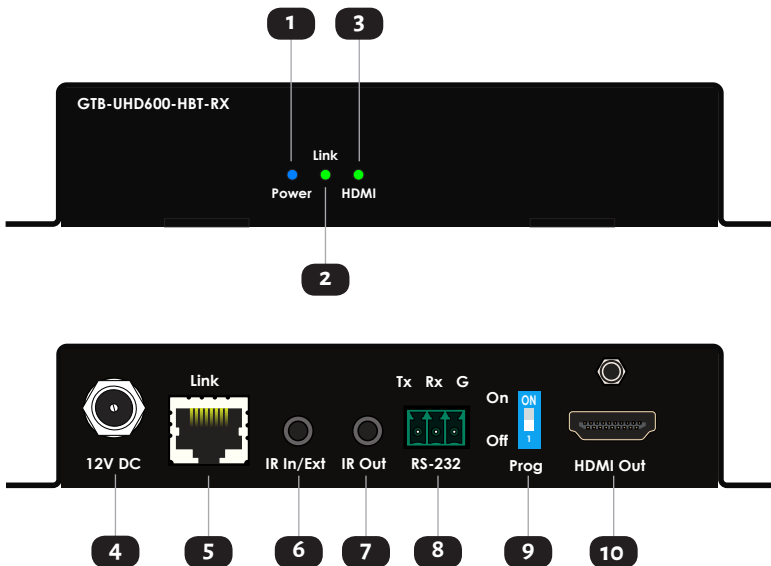

ID	Name	Description
1	Power	This LED indicator glows solid blue when the unit is powered. See LED Status (page 22) for more information.
2	Link	This LED glows solid green when a link is established between the Sender and Receiver. See LED Status (page 22) for more information.
3	HDMI	This LED indicator glows solid green when a source is connected to the HDMI In port. See LED Status (page 22) for more information.
4	12V DC	This power receptacle can be used to connect the included 12V DC power supply. Only one power supply is required for the extender system to operate. The power supply can be connected to either the Sender or Receiver unit.
5	Link	Connect a CAT-5e or better cable, shielded CAT-6A preferred, up to the recommended length for a given resolution, from this port to the Link port on the Sender unit.
6	IR In/Ext	3.5mm mini-stereo jack. Connect an IR Extender (Gefen part no. EXT-RMT-EXTIRN) to this port. Alternatively, connect a 3.5mm mini-stereo connector from this port to the output of an automation system with an electrical IR output. See IR Control (page 23) for more information on using IR.
7	IR Out	Connect an EXT-IREMIT IR Emitter (1 pc included) from this port to the IR sensor of the device to be controlled. See IR Control (page 23) for more information on using IR.

ID	Name	Description
8	RS-232	Connect Tx, Rx, and Ground from an automation control device, using the removable 3-pin “Captive Screw” Phoenix connector that is attached to the RS-232 port of the Receiver unit.
9	Prog	For normal operation, this switch should be in the Off (down) position. Setting this switch to the On (up) position, places the unit in firmware update mode. If either the Sender or the Receiver switch is in On position, extenders will not work. For the new setting of this switch to take effect, power needs to be removed from the unit by removing and reinstated by reconnecting them.
10	HDMI Out	Use a Gefen Locking HDMI cable, up to 10 feet long, to connect an Ultra HD display to this HDMI port.

GTB-UHD600-HBTL

Sender Unit

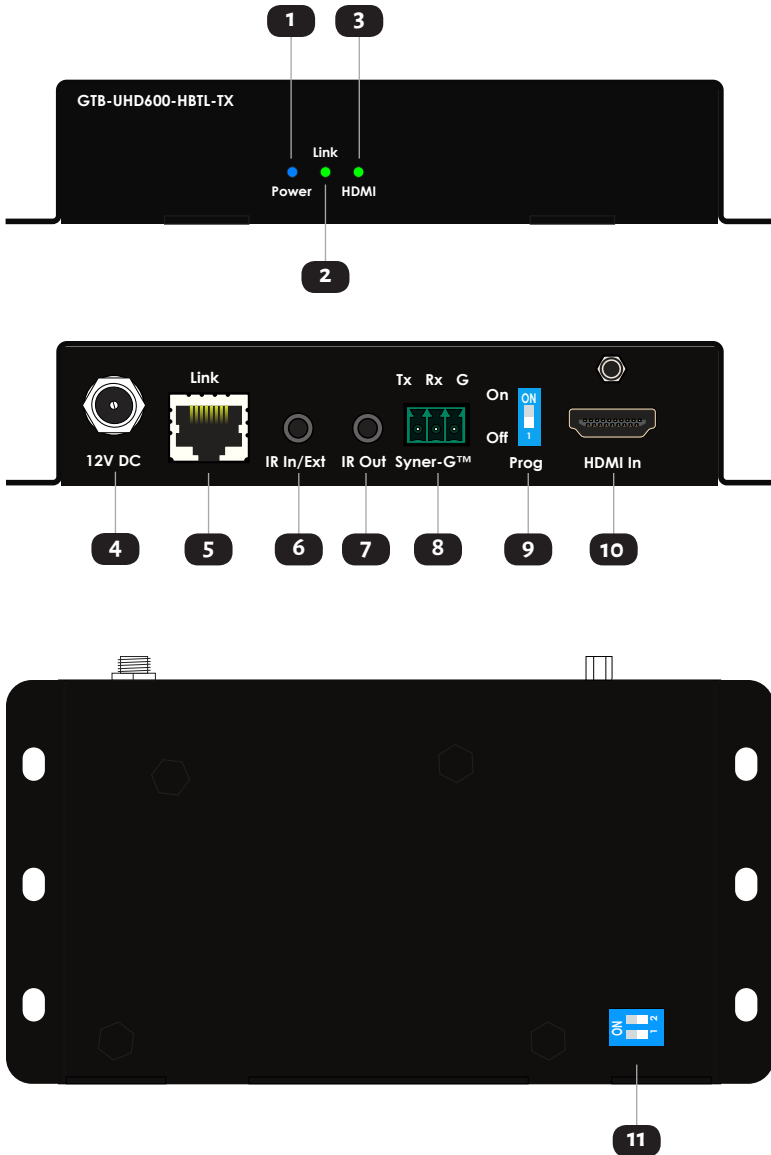

ID	Name	Description
1	Power	This LED indicator glows solid blue when the unit is powered. See LED Status (page 22) for more information.
2	Link	This LED glows solid green when a link is established between the Sender and Receiver. See LED Status (page 22) for more information.
3	HDMI	This LED indicator glows solid green when a source is connected to the HDMI In port. See LED Status (page 22) for more information.
4	12V DC	This power receptacle can be used to connect the included 12V DC power supply. Only one power supply is required for the extender system to operate. The power supply can be connected to either the Sender or Receiver unit.
5	Link	Connect a CAT-5e or better cable, shielded CAT-6A preferred, up to the recommended length for a given resolution, from this port to the Link port on the Receiver unit.
6	IR In/Ext	3.5mm mini-stereo jack. Connect an IR Extender (Gefen part no. EXT-RMT-EXTIRN) to this port. Alternatively, connect a 3.5mm mini-stereo connector from this port to the output of an automation system with an electrical IR output. See IR Control (page 23) for more information on using IR.
7	IR Out	Connect an EXT-IREMIT IR Emitter (1 pc included) from this port to the IR sensor of the device to be controlled. See IR Control (page 23) for more information on using IR.

ID	Name	Description
8	Syner-G™	This port is used for firmware update using Gefen Syner-G™
9	Prog	For normal operation, this switch should be in the Off (down) position. Setting this switch to the On (up) position, places the unit in firmware update mode. If either the Sender or the Receiver switch is in On position, extenders will not work. For the new setting of this switch to take effect, power needs to be removed from the unit by removing and reinstated by reconnecting them.
10	HDMI In	Use the included Locking HDMI cable to connect an Ultra HD source to this HDMI port.
11	DIP Switches	These DIP switches provide EDID management. See DIP Switch Configuration (page 26) for more information.

Receiver Unit

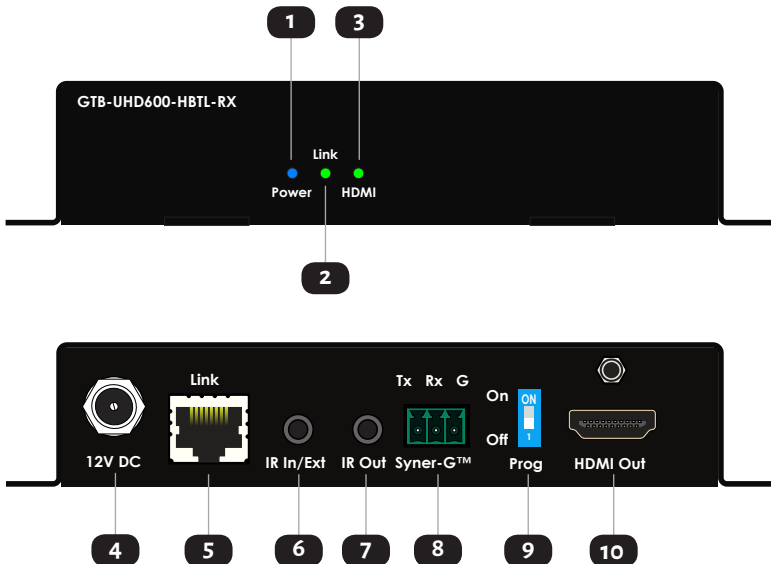

ID	Name	Description
1	Power	This LED indicator glows solid blue when the unit is powered. See LED Status (page 22) for more information.
2	Link	This LED glows solid green when a link is established between the Sender and Receiver. See LED Status (page 22) for more information.
3	HDMI	This LED indicator glows bright blue when an source is connected to the HDMI In port.
4	12V DC	This power receptacle can be used to connect the included 12V DC power supply. Only one power supply is required for the extender system to operate. The power supply can be connected to either the Sender or Receiver unit.
5	Link	Connect a CAT-5e or better cable, shielded CAT-6A preferred, up to the recommended length for a given resolution, from this port to the Link port on the Sender unit.
6	IR In/Ext	3.5mm mini-stereo jack. Connect an IR Extender (Gefen part no. EXT-RMT-EXTIRN) to this port. Alternatively, connect a 3.5mm mini-stereo connector from this port to the output of an automation system with an electrical IR output. See IR Control (page 23) for more information on using IR.
7	IR Out	Connect an EXT-IREMIT IR Emitter (1 pc included) from this port to the IR sensor of the device to be controlled. See IR Control (page 23) for more information on using IR.
8	Syner-G™	This port is used for firmware update using Gefen Syner-G™

ID	Name	Description
9	Prog	For normal operation, this switch should be in the Off (down) position. Setting this switch to the On (up) position, places the unit in firmware update mode. If either the Sender or the Receiver switch is in On position, extenders will not work. For the new setting of this switch to take effect, power needs to be removed from the unit by removing and reinstated by reconnecting them.
10	HDMI Out	Use a Gefen Locking HDMI cable, up to 10 feet long, to connect an Ultra HD display to this HDMI port.

Connection Instructions

▶ Video

1. Connect the included HDMI locking cable between the Ultra Hi-Def source and the **HDMI In** port on the Sender unit.
2. Connect an Ultra HD display to the **HDMI Out** port on the Receiver unit using another Gefen HDMI locking cable.

▶ CAT-5

3. Connect a CAT-5e or better cable, shielded CAT-6A preferred, from the **Link** port on the Sender unit to the **Link** port on the Receiver unit.

Note

Video resolution will affect maximum extension distance. Please see the Specifications section for recommended cable lengths.

▶ IR

4. Refer to [IR Control \(page 23\)](#) for details on connecting IR devices.

▶ RS-232 (GTB-UHD600-HBT only)

5. Connect Tx, Rx, and Ground from the RS-232 port of an automation control unit or a device-to-be-controlled, using the removable 3-pin “Captive Screw” Phoenix connector that is attached to the **RS-232** ports of the Sender and Receiver units. Each of the 3 pins is identified on the connector panel.

▶ Power

6. Connect the included 12V DC power supply to the power receptacle on either the Sender or Receiver unit. Power to the other unit will be supplied through the Link cable.
7. Connect the AC plug of the power supply to an available electrical outlet.

Sample Wiring Diagrams

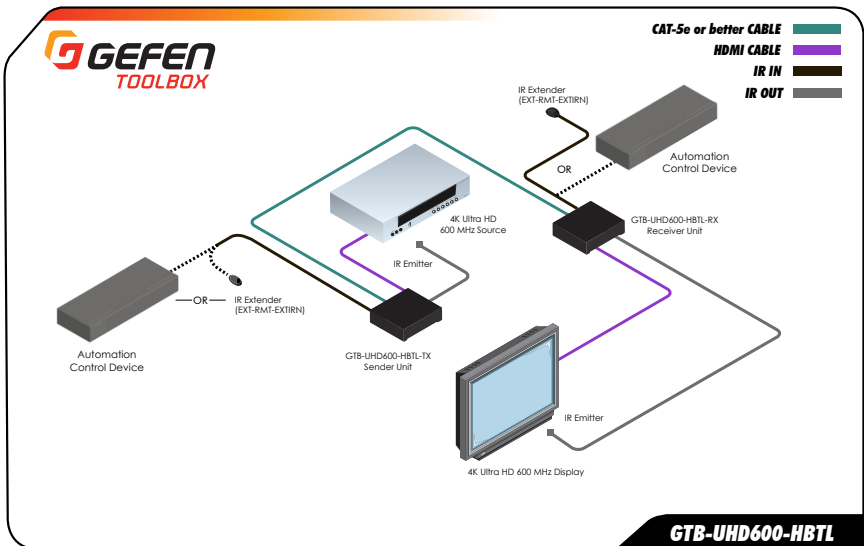
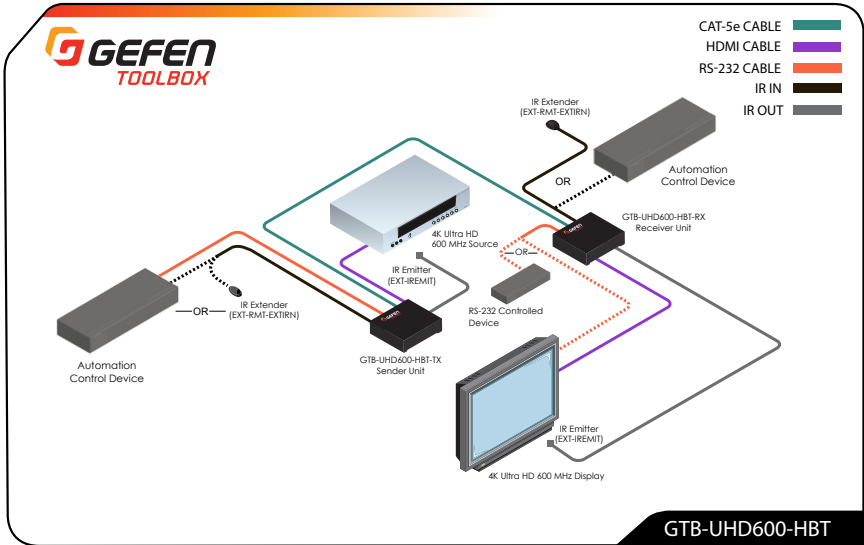



Notes



1. The wiring diagrams above show an additional IR emitter (Gefen part no. EXT-IREMIT) and IR extender (Gefen part no. EXT-RMT-EXTIRN) that are not included with the product. These are available for purchase from your Gefen distributor.
2. Power supply connections are not shown in the diagrams above. Power supply can be connected to Sender or Receiver. The other unit will receive power through the link cable,



LED Status

The **Power**, **Link**, and **HDMI** LED indicators on the Sender and Receiver unit provide basic information on the current status of each unit.

The information, in the table below, applies to both the Sender and Receiver unit.

Power		Description
Solid blue		<ul style="list-style-type: none">The Sender / Receiver unit is powered.
Off		<ul style="list-style-type: none">Check the power supply and the Link connection between the Sender and the Receiver unit.

Link		Description
Solid green		<ul style="list-style-type: none">Link integrity is good between the Sender and Receiver unit.
Off		<ul style="list-style-type: none">Check the power supply and the Link connection between the Sender and the Receiver unit.

HDMI		Description
Solid green		<ul style="list-style-type: none">Sender: Source is connected and powered.Receiver: Display / sink device is connected and powered.
Off		<ul style="list-style-type: none">Connect a source to the Sender unit; connect a display/sink to the Receiver unit. Make sure both source and sink are powered.

Controlling the Source from the Viewing Location

1. Connect an EXT-RMT-EXTIRN IR Extender (1 pc included) to the **IR In/Ext** port on the Receiver unit. If using an automation system, connect the 3,5mm mini-stereo connector from the **IR In/Ext** port on the Receiver unit to the IR Output port of the automation system. IR signals will be transmitted over the Link cable.
2. Connect an EXT-IREMIT IR Emitter from the **IR Out** port of the Sender unit, to the IR sensor window on the source device.

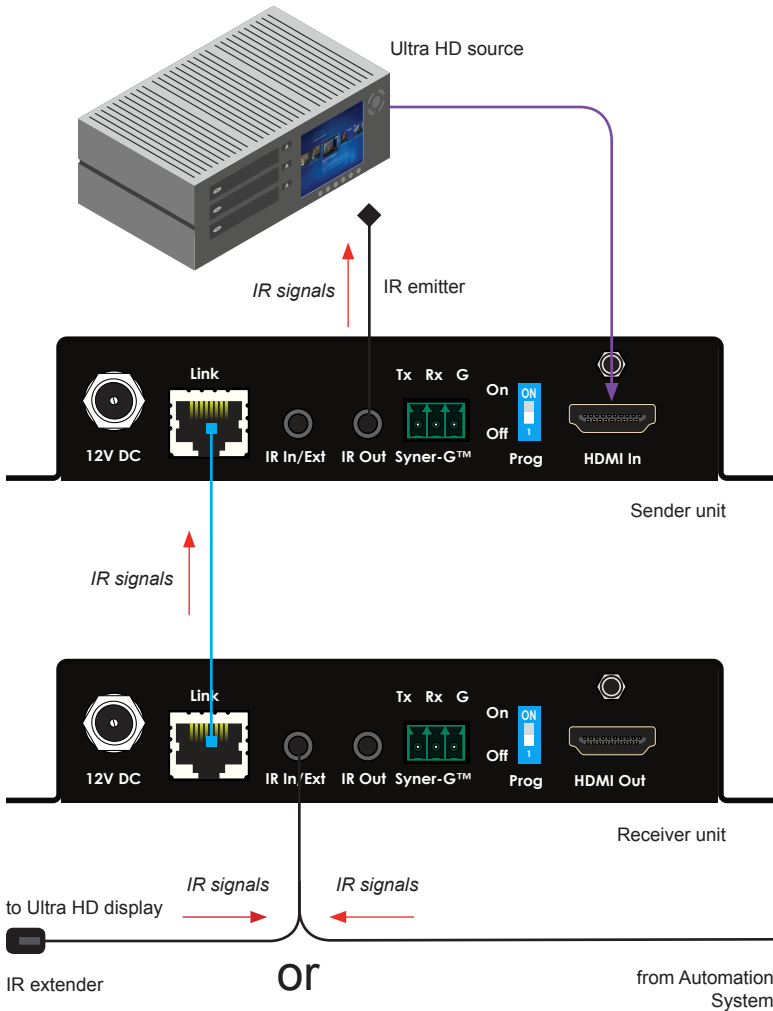

Controlling the Display from the Source Location

1. Connect an EXT-RMT-EXTIRN IR Extender (1 pc included) to the IR In/Ext port on the Sender unit. If using an automation system, connect the 3.5mm mini-stereo connector from the **IR In/Ext** port on the Receiver unit to the IR Output of the automation system. IR signals will be transmitted over the Link cable.
 2. Connect an EXT-IREMIT IR Emitter (1 pc included) from the **IR Out** port on the Receiver unit to the IR sensor on the display.
- IR extender

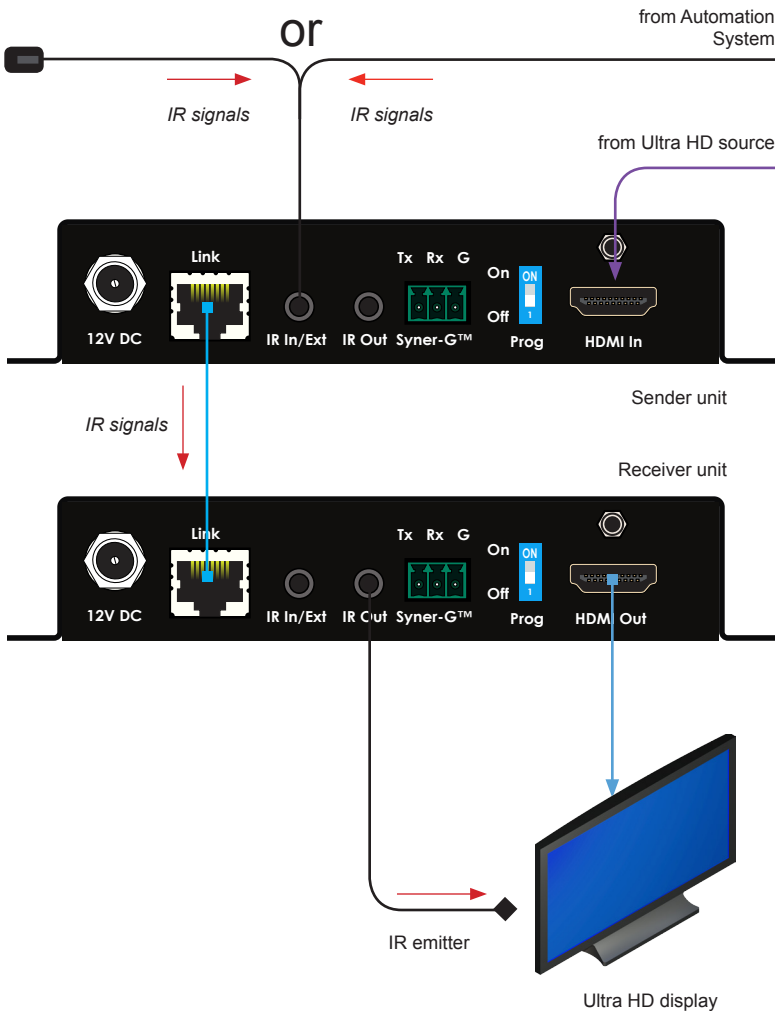

Controlling the Source & Display from the Head-End and Viewing Locations

1. This set-up will require an additional EXT-RMT-EXTIRN and EXT-IREMIT, sold separately by your Gefen distributor.
2. Follow instructions on page 23 and 24.

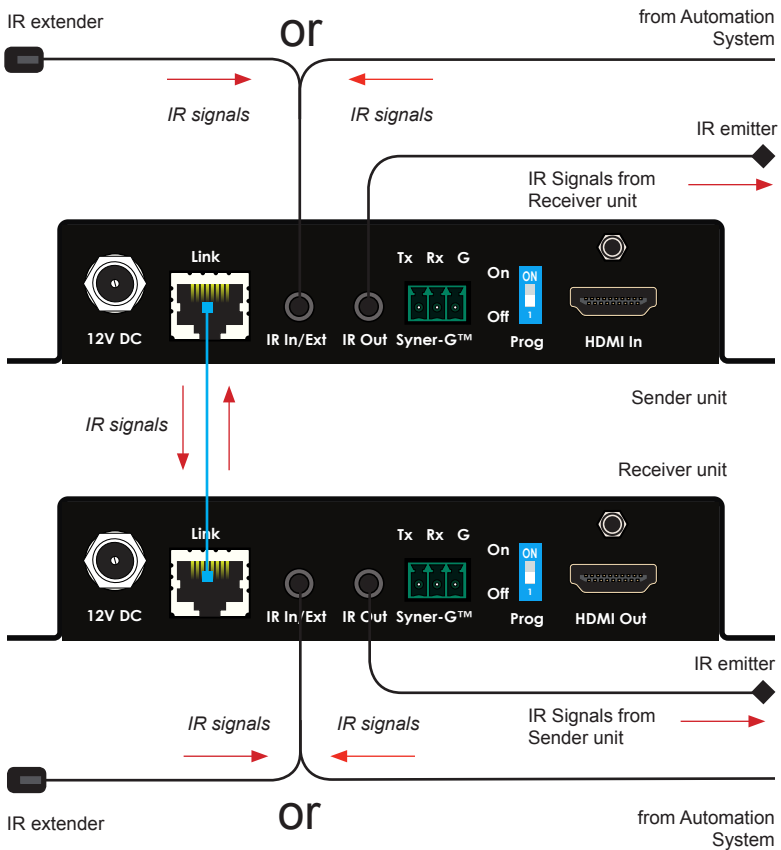

DIP Switch Configuration

The Sender unit has 2 EDID Management DIP Switches on its bottom panel, under a self-adhesive cover.

This product is shipped with its DIP switches set to enable 4K with 2-Channel Audio mode (SW1: OFF, SW2: ON).

Refer to the table below for DIP switch settings.

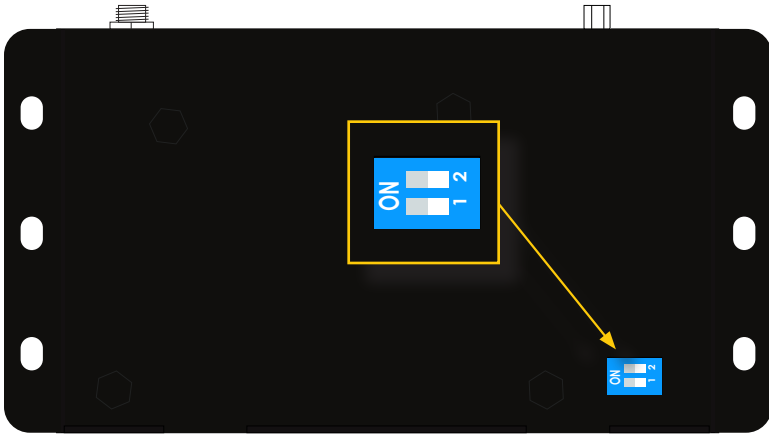

EDID Management

SW 1	SW 2	EDID Mode	DIP Switch Positions
OFF	N/A	External / Bypass EDID mode (default) <ul style="list-style-type: none"> Allows all video and audio features of the connected device to be passed to the source device. 	
ON	N/A	Internal EDID mode <ul style="list-style-type: none"> Enables the EDID modes on SW2. 	
ON	ON	4K 600 Multichannel Audio EDID mode <ul style="list-style-type: none"> 4K 600 MHz w/ Multichannel Audio 	
ON	OFF	4K 600 2-Channel Audio Mode (default) <ul style="list-style-type: none"> 4K 600 MHz w/ 2-Channel Audio 	

Connecting RS-232 Devices*

The CTB-UHD600-HBT supports RS-232 extension. The RS-232 interface is also used to upgrade the firmware using the Gefen Syner-G™ software.

1. Connect RS-232 Tx, Rx, and Ground from an automation control device to the removable 3-pin “Captive Screw” Phoenix connector that is attached to the **RS-232** port of the Sender unit. Each of the 3 pins is identified on the connector panel. If your automation device has a male DB-9 port and you prefer to not do the wiring, you can purchase an ADA-PH-2-DB9-MF-AB adaptor cable from your Gefen distributor. This adaptor cable has a female DB-9 on one end and a 3-pin Phoenix connector on the other.
2. Connect RS-232 Tx, Rx, and Ground from the device-to-be-controlled, to the removable 3-pin “Captive Screw” Phoenix connector that is attached to the **RS-232** port of the Receiver unit. Each of the 3 pins is identified on the connector panel. If the RS-232 device you wish to control has a female DB-9 port and you prefer to not do the wiring, you can purchase an ADA-PH-2-DB9-MM-AB adaptor cable from your Gefen distributor. This adaptor cable has a male DB-9 on one end and a 3-pin Phoenix connector on the other.
3. Since RS-232 is a bi-directional communications protocol, and depending on your application, you can also connect the automation controller to the receiver and the device-to-be-controlled to the sender.

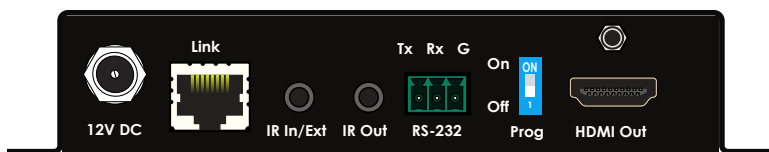

Important

The Prog switch must be set to the OFF position in order to enable serial (RS-232) extension. In addition, when sending RS-232 commands, a CR (ox0D) must be included.

* CTB-UHD600-HBT only

Firmware Update

1. Sender and Receiver should each be updated separately. To ensure proper operation, always update both units.
2. A Windows PC that is running Gefen Syner-G™ software, needs to be connected to the **RS-232** port of the GTB-UHD600-HBT or the **Syner-G™** port of the GTB-UHD600-HBTL. Sender and Receiver, either through a native RS-232 interface or using a USB-to-Serial adaptor.
3. Remove power from the unit to be updated, by disconnecting the **12V DC** power supply and the **Link** connector. Make sure that the **Prog** switch on the Sender or Receiver is in **On** (up) position, and then re-apply power to the unit by connecting the included power supply to the **12V DC** port and to an available electrical outlet. The power LED will glow to indicate that the unit is receiving power.
4. Connect RS-232 Tx, Rx, and Ground from the PC or USB-to-Serial adaptor to the removable 3-pin “Captive Screw” Phoenix connector that is attached to the **RS-232** or **Syner-G™** port of the Sender or Receiver to be updated. Each of the 3 pins is identified on the connector panel. If your PC or USB-to-Serial adaptor has a male DB-9 port and you prefer to not do the wiring, you can purchase an ADA-PH-2-DB9-MF-AB adaptor cable from your Gefen distributor. This adaptor cable has a female DB-9 on one end and a 3-pin Phoenix connector on the other.
5. Follow on-screen instructions in Gefen Syner-G™ to perform the firmware update on each unit.
6. Once a unit has successfully been updated, remove power from the unit, set the **Prog** switch to **Off** (down) position, and reconnect the Link cable and the power supply.

Specifications*

Supported Formats	
Maximum Video Resolution/Timing	<ul style="list-style-type: none"> 4K Cinema - DCI (4096 x 2160 to 60Hz, 4:4:4) 4K Ultra HD (3840 x 2160 to 60Hz, 4:4:4)
Audio (HDMI Pass-Thru)	<ul style="list-style-type: none"> Up to 8 channels of HBR, Bitstream, & LPCM
Connectors & Indicators	
Video Input Connector (Sender)	<ul style="list-style-type: none"> 1 x HDMI Type A 19-pin, locking, female
Video Output Connector (Receiver)	<ul style="list-style-type: none"> 1 x HDMI Type A 19-pin, locking, female
Link Connector (Sender / Receiver)	<ul style="list-style-type: none"> 1 x RJ-45, shielded
RS-232 Connector (Sender / Receiver)	<ul style="list-style-type: none"> 1 x 3-pin Phoenix (GTB-UHD600-HBT only)
Syner-G™ Connector (Sender / Receiver)	<ul style="list-style-type: none"> 1 x 3-pin Phoenix (GTB-UHD600-HBTL only)
IR In/Ext Connector (Sender / Receiver)	<ul style="list-style-type: none"> 1 x 3.5mm mini-stereo, female
IR Out Connector (Sender / Receiver)	<ul style="list-style-type: none"> 1 x 3.5mm mini-stereo, female
Power Connector (Sender / Receiver)	<ul style="list-style-type: none"> 1 x 12V DC, locking, 5.5mm barrel/2.1mm pin
Power Indicator (Sender / Receiver)	<ul style="list-style-type: none"> 1 x LED, blue
Link Indicator (Sender / Receiver)	<ul style="list-style-type: none"> 1 x LED, green
HDMI Indicator (Sender / Receiver)	<ul style="list-style-type: none"> 1 x LED, green
Operational	
TMDS Clock	<ul style="list-style-type: none"> 600 MHz
Video Bandwidth	<ul style="list-style-type: none"> 18.2 Gbps
Power Consumption (Sender/Receiver)	<ul style="list-style-type: none"> 14 W (max.), combined
Operating Temperature	<ul style="list-style-type: none"> +32 to +113 °F (0 to +45 °C)
Operating Humidity	<ul style="list-style-type: none"> 5% to 90% RH, non-condensing
Storage Temperature	<ul style="list-style-type: none"> -4 to +185 °F (-20 to +85 °C)
Storage Humidity (RH)	<ul style="list-style-type: none"> 0% to 95% RH, non-condensing
MTBF	<ul style="list-style-type: none"> 50000 hours
Physical	
Dimensions (W x H x D) (Sender / Receiver), not including connectors	<ul style="list-style-type: none"> 4.7" x 1" x 2.9" (119 mm x 26 mm x 73 mm)
Net Weight (Sender/Receiver)	<ul style="list-style-type: none"> 0.31 lbs (0.14 kg) each

* Features and specifications are subject to change without notice.
 All trademarks and registered trademarks are properties of their respective owners.
 Copyright© 2017 Core Brands, LLC



1800 S McDowell Blvd. Petaluma CA 94954, USA
1-707-283-5900 1-800-472-5555

Copyright© 2017 Core Brands, LLC.